

AUTOMATION

PRODUCTS
GROUP, INC.

Operator's Manual

PG10

Full Access

**DOC. 9003470
Part #200342
Rev B3 02/20**



Automation Products Group, Inc.

Table of Contents

Warranty	3
Programming the PG10.....	4-36
Menu Flow Chart	5
Mode Setting	6
Accessing/Exiting the Setup Menu.....	7
Maximum/Minimum Function	8
Units of Measure	9-10
Using Custom Units	10
Peak-Hold Feature	11
Advanced Settings	12-17
Auto-Off	12
Decimal Place	13
Sample Rate	14
Bar Graph.....	15
Range Adjustment.....	16
Fast Calibration	17
Datalogging	18-25
Date & Time	19
Logging Sample Rate.....	20
Event Logging	21-22
Disable/Clear Logging.....	23
Viewing Logged Readings.....	24
Enabling/Disabling the Clock	25
Tare Feature	26
Default.....	27
Outputs.....	28-32
Analog Outputs.....	28-29
Trip Point Outputs	30-32
Communications	33-36
Wiring	37-39
Specifications	40-41

- **Warranty and Warranty Restrictions**

This product is covered by APG's warranty to be free from defects in material and workmanship under normal use and service of the product for 24 months. For a full explanation of our Warranty, please visit <https://www.apgsensors.com/about-us/terms-conditions>. Contact Technical Support to receive a Return Material Authorization before shipping your product back.

Scan the QR code below to read the full explanation of our Warranty on your tablet or smartphone.



Programming the PG10



Each of the 4 buttons on the PG10 performs dual functions; one within the setup menu system, and another when in standard operating mode.



Mode Button

Primary Function: Used to access the main setup menu or to return to the main setup menu from any of the submenus.

Secondary Function: Used to cycle the gauge on and off by pressing and holding for approximately 2 seconds.



Enter Button

Primary Function: Used to accept the value displayed within each menu setting.

Secondary Function: Used to Zero the gauge or Tare the gauge (when the tare feature is enabled) by pressing and holding for approximately 3 seconds.



Up & Down Arrows

Primary Function: Used to cycle through all options and settings within the menu system.



Secondary Function: Used to cycle between the Minimum, Maximum and the present pressure reading.

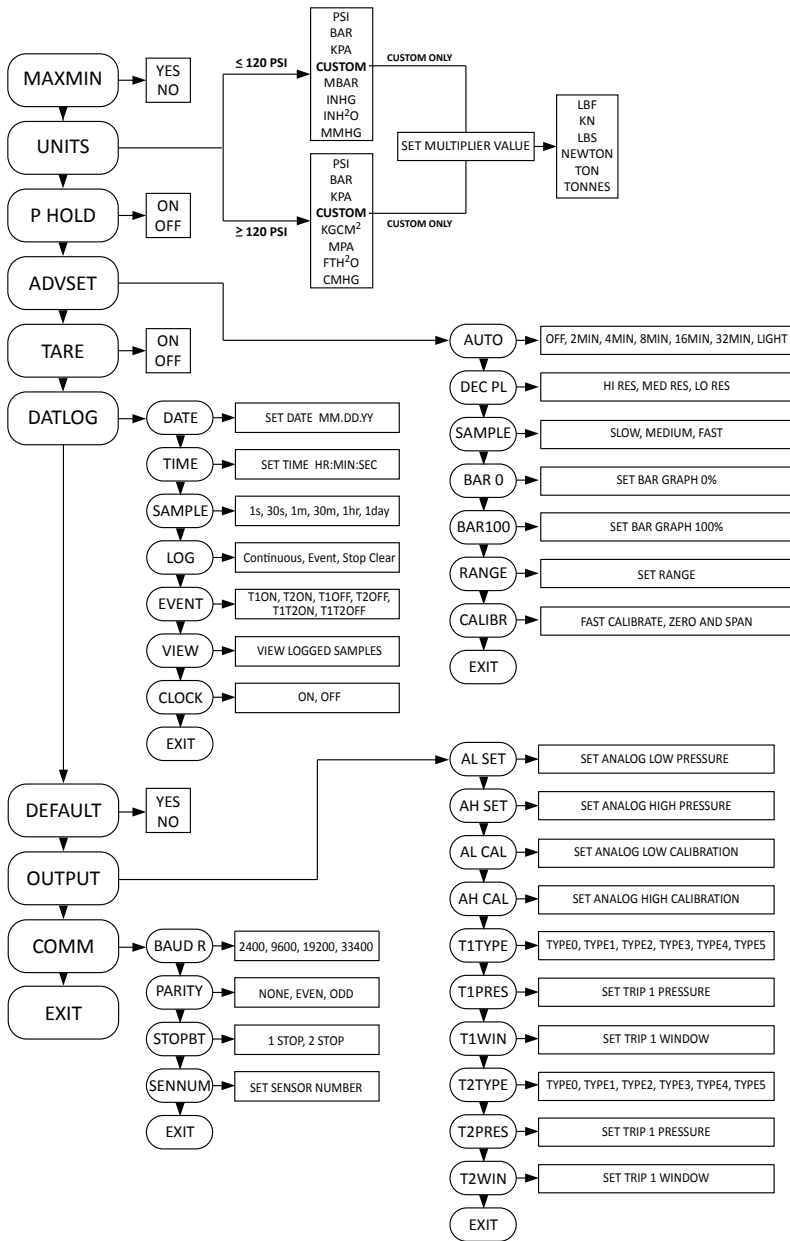





• Operating Modes:

The PG10 has 4 standard operating modes to choose from:

Mode 000: Full Access

- Provides access to all menu settings. **If no buttons are pushed for 1 minute, the gauge will revert back to Mode 003 (factory default).**

Mode 002: Limited Access

- Menu is locked.
-  zeros the reading (press and hold for 3 seconds).
-  or  cycles between the Max and Min readings.
-  On/Off functions only on battery powered gauges.



Mode 003: Factory Default



- Full access **except** Full Scale Calibration is locked.

Mode 005: Locked Access

- All buttons locked **except**  will power on/off battery powered gauges.

Accessing the Operating Mode Setting:

Step 1: Simultaneously press and hold  and  for approximately 3 seconds. This will bring up the 3 digit mode number.

Step 2: Enter the desired mode number (see Operating Modes above) by using  or  to change the value of the flashing digit, and  to accept the value and advance to the next digit.





Accessing the Setup Menu:

- Step 1:** Simultaneously press and hold and for approximately 3 seconds. This will bring up the 3 digit mode number.
- Step 2:** Using or to change the value of the flashing digit, and to advance to the next digit, change the mode number to **000**.
- Step 3:** Press to enter the setup menu, and press or to scroll through menu choices.

Exiting the Menu System:



- Step 1:** While in the main setup menu, press or until **EXIT** is displayed.
- Step 2:** Press to exit the menu system.

• **Maximum/Minimum Reset (MAXMIN):**

Pressing the  or  button while in operating mode will cycle between displaying the present pressure reading, the maximum pressure reading and the minimum pressure reading. The maximum and minimum readings will be stored until the gauge is powered down or the max/min readings are reset.

Resetting the Max/Min readings:

Step 1: Press  once to enter the main setup menu.

Step 2: Press  or  cycle through the options until **MAXMIN** is displayed.

Step 3: Press  to access the Max/Min reset options.

Step 4: Press  or  to toggle between **YES** and **NO** until **YES** is displayed.

Step 5: Press  to reset the Max/Min readings and return to the main setup menu.

• Units of Measure (UNITS):

Allows the user to select the unit of measure to be displayed as the pressure reading.

Options:

For gauges over 120 psi:

PSI	(pounds per square inch)
bAR	(bar)
KPA	(kilopascals)
*CUSTOM	(see “Using Custom Units” on next page)
KGCM^2	(kilograms per cubic centimeter)
MPA	(megapascals)
FTH20	(feet of water @ 60 F)
cmHG	(centimeters of mercury)

For gauges less than 120 psi:

PSI	(pounds per square inch)
bAR	(bar)
KPA	(kilopascals)
*CUSTOM	(see “Using Custom Units” on next page)
mbAR	(millibar)
INHG	(inches of mercury)
INH20	(inches of water @ 60 F)
mmHG	(millimeters of mercury)

Setting the Unit of Measure:

Step 1: Press  once to enter the main setup menu.

Step 2: Press  or  to cycle through the options until **UNITS** is displayed.

Step 3: Press  to access the Units options.

Step 4: Press  or  to cycle through setting options until the desired unit of measure is displayed.

Step 5: Press  to apply the setting and return to the main setup menu.

Using Custom Units (CUSTOM):

The Custom Units setting allows the user to display a volumetric weight by applying a conversion factor to the pressure reading.

NOTE: The conversion factor must be calculated using PSI as the base unit of measure.



Setting the Custom Units feature:

Step 1: Calculate the conversion factor from psi to the desired unit of measure.

Step 2: Press  once to enter the main setup menu.

Step 3: Press  or  to cycle through the options until **UNITS** is displayed.



Step 4: Press  to access the Units setting options.

Step 5: Press  or  to cycle through the Units options until **CUSTOM** is displayed.

Step 6: Press  to access the Custom Units setting. A 5-digit conversion factor will appear with the first digit flashing.

Step 7: Press  or  to change the value of the flashing digit.

Step 8: Press  to accept the flashing digit and advance to the next digit.....repeat steps 7 and 8 as necessary.

Step 9: After the last digit is accepted by pressing , use  or  scroll through the custom units of measure; **LBF, KN, LBS, KG, NEWTON, TON, TONNES.**

Step 10: Press  to accept the custom unit.

Step 11: Press  or  to shift the decimal point position.

Step 12: Press  to accept the decimal point position and return to the main setup menu.

- **Peak-Hold (P HOLD):**

When the Peak-Hold is enabled, the gauge will display the “peak” or maximum pressure reading since the gauge was powered on or the Max/Min value was reset.

NOTE 1: When the Peak-Hold feature is enabled, the **PEAK** icon will be displayed in the upper left area of the display.

Options: Off or On

Enabling the Peak-Hold feature:

Step 1: Press  to enter the main setup menu.

Step 2: Press  or  to cycle through the options until **P HOLD** is displayed.

Step 3: Press  to access the Peak-Hold setting options.

Step 4: Press  or  to toggle between **OFF** and **ON**.

Step 5: Press  to apply the displayed setting and return to main setup menu.

NOTE 2: The peak value can be reset by pressing 

• Advanced Settings (AdvSET):

The Advanced Settings menu is used to customize the LCD display and to setup any optional features, such as an analog output.

Auto-Off (AUTO):

This function is applicable to battery powered units only. The Auto-Off feature allows the user to designate the time of inactivity (no buttons pushed) until the gauge automatically powers down.

Options: OFF, 2 MIN, 4 MIN, 8 MIN, 16 MIN, 32 MIN and LIGHT

NOTE 1: Selecting OFF disables the Auto-Off feature; the gauge will then remain powered indefinitely so long as sufficient voltage is being supplied (>1.8V).

NOTE 2: Selecting LIGHT will keep the gauge continuously powered as long as the light sensor in the PG10 detects adequate light levels. When the environment is sufficiently dark, the PG10 will automatically shut down until the lighting once again reaches the threshold of the light sensor.

Setting the Auto-Off feature:



Step 1: Press  to enter the main setup menu.

Step 2: Press  or  to cycle through the menu options until **AdvSET** is displayed.



Step 3: Press  to enter the Advanced Settings menu.

Step 4: Press  or  to cycle through the menu options until **AUTO** is displayed.

Step 5: Press  to access the Auto-Off setting options.

Step 6: Press  or  to cycle through setting options until the desired setting is displayed.

Step 7: Press  to apply the setting and return to advanced setup menu.

Step 8: To exit the advanced setup menu, press  or  until **EXIT** is displayed and press  to exit to the main setup menu.













Decimal Place (dEC PL):

The reading can be set to display in High Resolution (HI RES), Medium Resolution (MEdRES) or Low Resolution (LO RES) mode. Switching between resolutions will shift the displayed reading by one decimal place position.

NOTE: Gauges without a decimal place position will display a dummy zero (or zeros) when the resolution is changed to medium or low.

Options: HI RES (high resolution), MEdRES (medium resolution) or LO RES (low resolution)

Setting the Decimal Place feature:

- Step 1:** Press  to enter the main setup menu.
- Step 2:** Press  or  to cycle through the options until **AdVSET** is displayed.
- Step 3:** Press  to enter the Advanced Settings menu.
- Step 4:** Press  or  to cycle through the options until **dEC PL** is displayed.
- Step 5:** Press  to access the Decimal Place setting options.
- Step 6:** Press  or  to cycle through the resolution settings.
- Step 7:** Press  to apply the displayed setting and return to advanced setup menu.
- Step 8:** To exit the advanced setup menu, press  or  until **EXIT** is displayed and press  to exit to the main setup menu.

Sample Rate (SAMPLE):

Adjusts the rate at which the gauge takes sample readings.

NOTE: Setting the Sample Rate to “SLOW” will help preserve battery life (when applicable) and will also help to smooth rapidly fluctuating readings.



Options: SLOW (4x/second), MEdIUM (8x/second), FAST (16x/second)

Setting the Sample Rate feature:

Step 1: Press  to enter the main setup menu.

Step 2: Press  or  to cycle through the options until **AdVSET** is displayed.

Step 3: Press  to access the Advanced Settings menu.

Step 4: Press  or  to cycle through the options until **SAMPLE** is displayed.

Step 5: Press  to access the Sample Rate setting options.

Step 6: Press  or  to cycle through the setting options until the desired setting is displayed.

Step 7: Press  to apply the displayed setting and return to advanced setup menu.

Step 8: To exit the advanced setup menu, press  or  until **EXIT** is displayed and press  to exit to the main setup menu.



Bar Graph 0% (bAR 0) & Bar Graph 100% (bAR100) Settings:

Allows the user to define the reading values associated with 0% and 100% on the 270° display bar graph. Bars will appear/disappear in 10% increments of the total span between the two values.

NOTE: The 0% reference does not have to be the lower pressure setting; 0% can be set as the higher pressure setting, thereby causing the bar graph to increase as the pressure decreases. Negative pressure settings can also be used as either the 0% or 100% reference points.

Setting the Display Bar Graph:

Step 1: Press  once to enter the main setup menu.

Step 2: Press  or  to cycle through the options until **AdVSET** is displayed.



Step 3: Press  to access the Advanced Settings menu.

Step 4: Press  or  to cycle through the options until **BAR 0** is displayed.

Step 5: Press  to access the Bar Graph 0% value. A 5-digit number will appear with the first digit flashing.

Step 6: Press  or  to change the value of the first flashing digit.

Step 7: Press  to accept the value of the flashing digit and advance to the next digit.....repeat steps 6 and 7 until the desired 0% reading is fully entered.

Step 8: Press  or  to cycle through the options until **BAR100** is displayed.

Step 9: Repeat Steps 5-7 to enter the Bar Graph 100% value.

Step 10: To exit the advanced setup menu, press  or  until **EXIT** is displayed and press  to exit to the main setup menu.

Full-Scale Range Adjust (RANGE):



Allows the user to adjust the reading at full-scale pressure. The reading can be adjusted by +/-10% full-scale.

NOTE: The pressure reading must be within 5% of the full-scale value in order to make Range adjustments. For example, a 1000 psi gauge would need to be reading between 950 psi and 1050 psi in order to adjust the Range feature. If the reading is not within 5% of full scale, NOAdJU (No Adjustment) will be displayed when trying to adjust the Range.



Adjusting the Full-Scale Range:

Step 1: Ensure that the pressure reading is within 5% of full-scale.

Step 2: Press  to enter the main setup menu.

Step 3: Press  or  to cycle through the options until **AdVSET** is displayed.



Step 4: Press  to access the Advanced Settings menu.

Step 5: Press  or  to cycle through the options until **RANGE** is displayed.

Step 6: Press  to enter the Range adjust mode.

Step 7: Press  to **increase** the reading, or press  to **decrease** the reading.

Step 8: Press  to accept the adjusted reading and return to the advanced setup menu.

Step 9: To exit the Advanced Setup menu, press  or  until **EXIT** is displayed and press  to exit to the main setup menu.

Fast Calibration (CALIBR):



Allows the user to perform a fast calibration of the zero and span.

NOTE: Both zero pressure and full-scale pressure must be applied to the gauge in order to complete the quick calibration process.

Step 1: Press  to enter the main setup menu.

Step 2: Press  or  to cycle through the menu options until **AdVSET** is displayed.

Step 3: Press  to enter the Advanced Settings menu.

Step 4: Press  or  to cycle through the options until **CALIBR** is displayed.

Step 5: Press  to access the **CALIBR** mode. The gauge will display the word **ZERO**, prompting the user to perform the zero pressure quick calibration.

Step 6: Ensure no pressure is applied to the gauge. Press  to zero the gauge. The gauge will then display the word **SPAN**, prompting the user to perform the full-scale pressure quick calibration.

Step 7: Apply full pressure to the gauge and press  to complete the quick calibration and return to advanced setup menu.

Step 9: To exit the advanced setup menu, press  or  until **EXIT** is displayed and press  to exit to the main setup menu.

- **Datalogging (dATLOG):**

When datalogging is enabled, the PG10 will log the pressure readings, along with the associated date/time stamps, at an interval determined by the Logging Sample Rate setting (see page 20).

The PG10 can be configured to log continuously, based solely on the Logging Sample Rate setting, or to log only when user defined pressure conditions exist (event logging). The gauge will continue to log readings at the Logging Sample Rate interval for as long as the event conditions persist.



The gauge can store a maximum of 60 records. Each record is logged in a FIFO (first-in, first-out) buffer. This means that once the buffer is full (60 records), the oldest record will be overwritten by the next logged reading.

Date (DATE) and Time (TIME):



Used to set the date and time, which will be used as the reference for the time stamp of the logged readings.

NOTE: Hours are set using the 24 hour system (e.g. 1:00 p.m. is 13:00).





Step 1: Press  to enter the main setup menu.

Step 2: Press  or  to cycle through the menu options until **datLOG** is displayed.



Step 3: Press  to enter the Datalogging menu options.

Step 4: Press  or  to cycle through the menu options until **DATE** is displayed.

Step 5: Press  to access the Date settings. A 2-digit month number will appear with the first digit flashing.

Step 6: Press  or  to cycle the first digit, and  to accept the value and advance to the second digit. Repeat the same process for the second digit and press  to accept and advance to the day of the month setting, which will appear with the first digit flashing. Repeat the process one last time by entering the year.

Step 7: Press  to apply the setting and return to Datalogging menu.

Step 8: Press  or  to cycle through the menu options until **TIME** is displayed.

Step 9: Press  to access the time settings. Repeat the process used to set the date to set the time (hour, minute, seconds).



Logging Sample Rate (SAMPLE):

Determine the interval between logged readings whenever logging is activated.



Options: 1 second (1s), 30 seconds (30s), 1 minute (1m), 30 minutes (30m), 1 hour (1h), and 1 day (1day).

Setting the Logging Sample Rate:



Step 1: Press  to enter the main setup menu.

Step 2: Press  or  to cycle through the options until **dATLOG** is displayed.

Step 3: Press  to enter the Datalogging menu.

Step 4: Press  or  to cycle through the options until **SAMPLE** is displayed.

Step 5: Press  to access the Logging Sample Rate setting options.

Step 6: Press  or  to cycle through the sample rate settings.

Step 7: Press  to apply the displayed setting and return to Datalogging menu.

Logging Control Menu (LOG):

Used to enable/disable datalogging, and to clear all logged records.

Setting the Logging Type (continuous or event):



The PG10 can be set to continuously log readings or to only log readings based on the Trip Relay status.

NOTE 1: Gauges not equipped with relay outputs will still use the Trip Relay settings to define the pressure range(s) for the event logging (see pages 30-32 programming details).



NOTE 2: Whenever the PG10 is logging, whether in continuous or event mode, the interval between logged readings is determined by the Logging Sample Rate setting (see page 20).

Enabling Continuous or Event Logging



Step 1: Press  to enter the main setup menu.

Step 2: Press  or  to cycle through the options until **DATLOG** is displayed.

Step 3: Press  to enter the Datalogging menu.

Step 4: Press  or  to cycle through the options until **LOG** is displayed.

Step 5: Press  to access the Logging Control options.

Step 6: Press  or  to cycle through the setting options until **CONTIN** or **EVENT** is displayed.

Step 7: Press  to enable logging and return to logging control menu.

Setting Event Logging:

When Event Logging is enabled, the gauge will log readings based on the status of one or both of the Trip Relays (see Trip Relay programming on pages 30-32).

NOTE: Gauges not equipped with relay outputs will still use the Trip Relay settings for event logging.

Event logging can be set to initiate on one of the following conditions:

When Trip 1 is On (T1ON)

When Trip 2 is On (T2ON)



When both Trip 1 & Trip 2 are On (T1T2ON)

When both Trip 1 & Trip 2 are Off (T1T2OF)



When Trip 1 is Off (T1OFF)

When Trip 2 is Off (T2OFF)

Step 1: Press  to enter the main setup menu.

Step 2: Press  or  to cycle through the options until **dATLOG** is displayed.

Step 3: Press  to enter the Datalogging menu.











Step 4: Press  or  to cycle through the options until **EVENT** is displayed.

Step 5: Press  to access the Event options.

Step 6: Press  or  to cycle through the options until the desired Event condition is displayed.

Step 7: Press  to accept the event condition and return to the Datalogging menu.



Disabling Logging (STOP) and Clearing Logged (CLEAR) Readings:

- Step 1:** Press  to enter the main setup menu.
- Step 2:** Press  or  to cycle through the options until **dATLOG** is displayed.
- Step 3:** Press  to enter the Datalogging menu.
- Step 4:** Press  or  to cycle through the options until **LOG** is displayed.
- Step 5:** Press  to access the Logging Control options.
- Step 6:** Press  or  to cycle through the setting options until **STOP** or **CLEAR** is displayed.
- Step 7:** Press  to apply the displayed option (stop or clear) and return to Datalogging menu.

Viewing Logged Readings (VIEW):

The latest reading will be the first record displayed when viewing the logged readings.



Step 1: Press  to enter the main setup menu.

Step 2: Press  or  to cycle through the options until **dATLOG** is displayed.

Step 3: Press  to enter the Datalogging menu.

Step 4: Press  or  to cycle through the options until **VIEW** is displayed.

Step 5: Press  to access the logged readings.

Step 6: Press  to cycle back through progressively older readings.  will cycle forward through progressively newer records.

Step 7: Press  to exit the logged readings.

NOTE: When viewing a logged record, the time stamp of the record will toggle momentarily to display the date stamp once every 8 seconds.



Enabling and Disabling the Clock on the main display (CLOCK):

When enabled, the time will be displayed on the lower line (menu line) of the main display, alternating every two seconds with the unit of measure.



Options: ON or OFF

Enabling or Disabling the Main Display Clock:



Step 1: Press  to enter the main setup menu.

Step 2: Press  or  to cycle through the options until **dATLOG** is displayed.

Step 3: Press  to enter the Datalogging menu.

Step 4: Press  or  to cycle through the options until **CLOCK** is displayed.

Step 5: Press  to access the Clock on/off option.

Step 6: Press  or  to cycle between the options.

Step 7: Press  to apply the displayed option and return to Datalogging menu.

• Tare (TARE):



Enabling the Tare function will set the current pressure reading as the zero reference pressure in order to measure a net change in pressure as opposed to measuring the gross pressure.

Enabling the Tare feature:

Step 1: Press  to enter the main setup menu.

Step 2: Press  or  to cycle through the options until **TARE** is displayed.

Step 3: Press  to access the Tare setting options.

Step 4: Press  or  to toggle between **OFF** and **ON**.

Step 5: Press  button to apply the displayed option and return to main setup menu.

NOTE 1: When tare function is enabled, the  icon will appear in the upper center of the display.

WARNING: Do **NOT** disconnect the gauge from the pressure fitting while the tare function is enabled. The gauge could still be under pressure even though the reading shows 0.

NOTE 2: If the maximum gross full-scale pressure value is reached while the Tare feature is enabled, the PG10 will automatically disable the Tare feature and return to reading the gross pressure in order to help prevent the user from accidentally overpressuring the gauge.



NOTE 3: Pressing and holding  with the tare function enabled will re-tare the gauge at the current pressure value.

- **Default (dEFAULT):**

Used to reset the gauge to the factory default settings.

Resetting the gauge to factory default settings:

Step 1: Press  to enter the main setup menu.

Step 2: Press  or  to cycle through the options until **dEFAULT** is displayed.

Step 3: Press  to access the Default options.

Step 4: Press  or  to cycle between **NO** and **YES**.

Step 5: Press  to apply the displayed setting and return to main setup menu.

• OUTPUT:

Used to configure any optional gauges outputs, such as an analog signal or trip point relays.



Analog Low (AL SET) & Analog High (AH SET) Setpoints:

Allows the user to define the reading values associated with the Low Analog signal (i.e. 4mA or 0V) and the High Analog signal (i.e. 20mA, 2V or 5V).



NOTE: The analog setpoints must be entered using the gauge's base unit of measure (typically PSI).

Setting the Analog Signal Span:



Step 1: Press  to enter the main setup menu.

Step 2: Press  or  to cycle through the options until **OUTPUT** is displayed.

Step 3: Press  to access the Output Settings menu.



Step 4: Press  or  to cycle through the options until **AL SET** is displayed.

Step 5: Press  to access the Analog Low setpoint value. A 5-digit number will appear with the first digit flashing.

Step 6: Press  or  to change the value of the first flashing digit.

Step 7: Press  to accept the value of the flashing digit and advance to the next digit.....repeat steps 6 and 7 until the desired Analog Low reading is fully entered.

Step 8: Press  to reenter the Output Settings menu.

Step 9: Press  or  to cycle through the options until **AH SET** is displayed.

Step 10: Repeat Steps 5-7 to enter the Analog High setpoint value.

Step 11: To exit the output menu, press  or  until **EXIT** is displayed and press  to exit to the main setup menu.

Analog Low (AL CAL) & Analog High (AH CAL) Calibration:



Allows the user to calibrate or “trim” the endpoints of the analog signal output (i.e. 4mA & 20mA or 0V & 2V/5V)

Calibrating the Analog Signal End-Points:

Step 1: Use a calibrated meter to monitor the analog output signal.

Step 2: Force a low analog output signal (i.e. 4mA or 0V) either by adjusting the applied pressure or by adjusting the Analog Setpoints (see “Analog Setpoints” on page 18 for details).

Step 3: Press  to enter the main setup menu.

Step 4: Press  or  to cycle through the options until **Output** is displayed.

Step 5: Press  to access the Output Settings menu.

Step 6: Press  or  to cycle through the setup options until **AL CAL** is displayed.



Step 7: Press  to access the Analog Low Calibration value. A 5-digit number will appear with the first digit flashing.

Step 8: Press  or  to change the value of the flashing digit.

NOTE: Changing the digit farthest to the left will produce the coarsest adjustment, while each successive digit moving to the right will cause subsequently finer adjustments.

Step 9: Press  to accept the value of the flashing digit and advance to the next digit.....repeat steps 7 and 8 until the desired Analog Output value is displayed on the meter.

Step 10: Press  to reenter the Output Settings menu.

Step 11: Press  or  to cycle through the options until **AH CAL** is displayed.

Step 12: Repeat Steps 7-9 to adjust the Analog High Calibration value.

Step 13: To exit the output menu, press  or  until **EXIT** is displayed and press  to exit to the main setup menu.

Trip Points: The PG10 can be configured with dual relay trip-point outputs. The relays are SPDT mechanical in form. Each trip point (T1 and T2) can be configured to perform one of six different logic functions as described below and on the chart on the next page.

NOTE: The T1 or T2 icon will appear in the upper left area of the display whenever the associated trip point is active.

Trip Relay Output Types (T1TYPE or T2TYPE): determines the logic function of the output relays (see chart on next page).

“Type 0” or Normally Closed setting will close the trip relay whenever the pressure is less than the Trip Pressure setting.

“Type 1” or Exclusive setting will close the trip relay whenever the pressure is less than the Trip Pressure or greater than the Trip Pressure + Trip Window.

“Type 2” or Normally Closed with Hysteresis setting will close the trip relay when the pressure drops below the Trip Pressure. Once closed, the trip relay will remain closed until the pressure becomes greater than the Trip Pressure + Trip Window, at which point the trip relay will open. Once open the trip relay will remain open until the pressure once again drops below the Trip Pressure setting.

“Type 3” or Normally Open setting will close the relay whenever the pressure is greater than the Trip Pressure setting.

“Type 4” or Inclusive setting will close the relay whenever the pressure is within the Trip Window pressure range (greater than the Trip Pressure, less than the Trip Pressure + Trip Window).

“Type 5” or Normally Open with Hysteresis is used for pump up applications, or for a low level alarm with hysteresis function. This is the opposite function of the Type 2.

“Type 6” Trip Disable

Trip Pressure: determines the lower pressure point for the trip output function.

Trip Window: determines the pressure range between the lower and upper trip pressures. Used for Types 1, 2, 4, 5 (see chart below).

*TP=TRIP PRESSURE
TW=TRIP WINDOW*

*TYPE 0
NORMALLY CLOSED
TRIP WINDOW = 0*

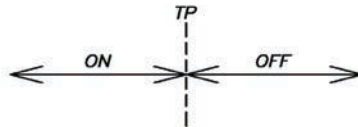

*TYPE 1
EXCLUSIVE*

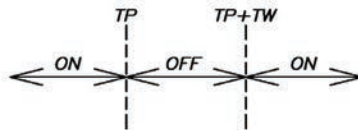

*TYPE 2
NORMALLY CLOSED
WITH HYSTERESIS*

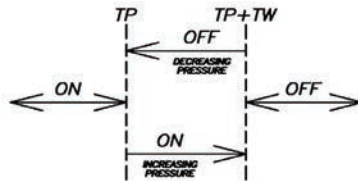

*TYPE 3
NORMALLY OPEN
TRIP WINDOW = 0*

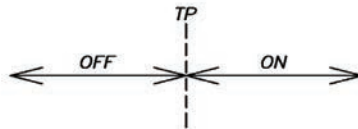



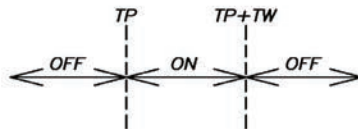



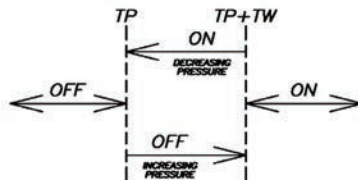

















*TYPE 4
INCLUSIVE*



*TYPE 5
NORMALLY OPEN
WITH HYSTERESIS*



Setting the Trip Point Outputs:

- Step 1:** Press  once to enter the main setup menu.
- Step 2:** Press  or  to cycle through the options until **OUTPUT** is displayed.
- Step 3:** Press  to access the Output Settings menu.
- Step 4:** Press  or  to cycle through the options until **T1TYPE** (or **T2TYPE**) is displayed.
- Step 5:** Press  to access the Trip Type setting.
- Step 6:** Press  or  to change the setting to the desired trip type function.
- Step 7:** Press  to accept the trip type function and return to the Output Settings menu.
- Step 8:** Press  or  to cycle through the Output menu options until **T1PRES** (or **T2PRES**) is displayed.
- Step 9:** Press  to enter the Trip Pressure setting. A 5-digit number will appear with the first digit flashing.
- Step 10:** Press  or  to change the value of the first flashing digit.
- Step 11:** Press  to accept the value of the flashing digit and advance to the next digit.....repeat steps 10 and 11 until the desired Trip Pressure is fully entered.
- Step 12:** Press  or  to cycle through the Output menu options until **T1WIN** (or **T2WIN**) is displayed.
- Step 13:** Press  to enter the Trip Window setting. A 5-digit number will appear with the first digit flashing.
- Step 14:** Press  or  to change the value of the first flashing digit.
- Step 15:** Press  to accept the value of the flashing digit and advance to the next digit.....repeat steps 14 and 15 until the desired Trip Window is fully entered.
- Step 11:** To exit the output menu, press  or  until **EXIT** is displayed and press  to exit to the main setup menu.

• Communications (COMM):

Used to configure RS-485 Modbus communications settings (on models equipped).



NOTE: The PG10 can function only as a slave device.

Baud Rate (bAUd R):



Sets the baud rate for the RS-485 communications. Options are 2400, 9600, 19200, 33400

Setting the Baud Rate:

Step 1: Press  to enter the main setup menu.

Step 2: Press  or  to cycle through the options until **COMM** is displayed.

Step 3: Press  to access the Communications settings menu.

Step 4: Press  or  to cycle through the options until **bAUd R** is displayed.

Step 5: Press  to access the Baud Rate setting.

Step 6: Press  or  to cycle through the baud rate settings.



Step 7: Press  to accept the settings and return to the Communication settings menu

Parity (PARITY):

Sets the parity for the RS-485 communications. Options: None, Even, Odd

Setting the Communications Parity:

Step 1: Press  to enter the main setup menu.

Step 2: Press  or  to cycle through the options until **COMM** is displayed.

Step 3: Press  to access the Communications settings menu.

Step 4: Press  or  to cycle through the options until **PARITY** is displayed.

Step 5: Press  to access the communication Parity setting.

Step 6: Press  or  to change cycle through the parity options.



Step 7: Press  to accept the return to the Communications menu.

Stop Bits (STOPbT):



Sets the number of stop bits for the RS-485 communications. Options: 1 Stop bit, 2 Stop bits

Setting the number of Stop Bits:

Step 1: Press  to enter the main setup menu.

Step 2: Press  or  to cycle through the options until **COMM** is displayed.

Step 3: Press  to access the Communications settings menu.

Step 4: Press  or  to cycle through the options until **STOPbT** is displayed.

Step 5: Press  to access the Stop Bit setting.

Step 6: Press  or  to cycle through the settings options.



Step 7: Press  to accept the settings and return to the Communication settings menu

Sensor Number (SENNUM):



Sets the PG10's sensor address number for the RS-485 Modbus communications. Options: 1 Stop bit, 2 Stop bits

Setting the number of Stop Bits:



Step 1: Press  to enter the main setup menu.

Step 2: Press  or  to cycle through the options until **COMM** is displayed.

Step 3: Press  to access the Communications settings menu.

Step 4: Press  or  to cycle through the options until **SENNUM** is displayed.

Step 5: Press  to access the Sensor Number setting. A 3-digit number will appear with the first digit flashing.

Step 6: Press  or  to change the value of the first flashing digit.

Step 7: Press  to accept the value of the flashing digit and advance to the next digit.....repeat steps 6 and 7 until the desired sensor address number is entered. The PG10 will automatically return to the Communications menu once the last digit is entered.

Wiring the PG10

Battery Replacement:

Step 1: Untwist the display locking ring (on the face of the gauge) counter-clockwise until the ring releases the display from the gauge.

Step 2: Remove the front display to access the batteries.

Step 3: Replace the front display ensuring proper alignment and secure into place using the locking ring.

8 Pin Connector Wiring:

PG10 Pinout Table

	L1	L1-C4	L4	L4-C4
	4-20 mA	2 SPDT Relays with 4-20 mA	External Power	2 SPDT Relays with 4-20 mA
8 Pin Connector	1	+ Excitation	+ Excitation	+ Excitation
	2	n/a	- Excitation	- Excitation
	3	- Excitation	Relay 1 Com	Relay 1 Com
	4	n/a	Relay 1 NC	Relay 1 NC
	5	n/a	Relay 1 NO	Relay 1 NO
	6	n/a	Relay 2 Com	Relay 2 Com
	7	n/a	Relay 2 NC	Relay 2 NC
	8	n/a	Relay 2 NO	Relay 2 NO

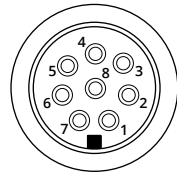

	L2	L3	L3-C4	L5	L5-C4
	0-2 VDC with Battery Power	0-5 VDC with External Power	0-5 VDC with 2 Tied SPDT Relays	RS-485 with External Power	RS-485 with 2 NO Relays
8 Pin Connector	1	n/a	+ Excitation	+ Excitation	+ Excitation
	2	- Output	- Excitation	-Exc/Out	- Excitation
	3	+ Output	+ Output	+ Output	RS-485 A (+)
	4	n/a	- Output	Relay 1 NC	RS-485 B (-)
	5	n/a	n/a	Relay 1 NO	n/a
	6	n/a	n/a	Relay 1/2 Com	n/a
	7	n/a	n/a	Relay 2 NC	n/a
	8	n/a	n/a	Relay 2 NO	n/a

n/a indicates no pin connection

Wiring (continued)

L1: 4-20 mA Circuit

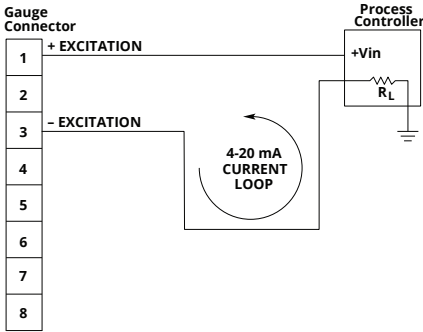

L1: 4-20 mA Circuit (C4 relay option shown)

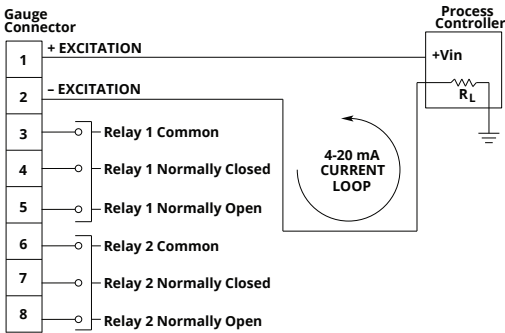

L2: 0-2 V (battery powered) (C4 relay option not available)

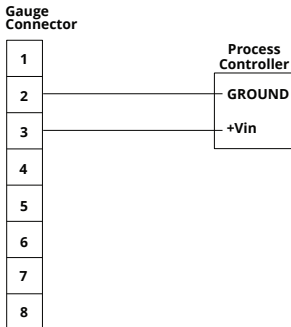

Wiring (continued)

L3: 0-5 V

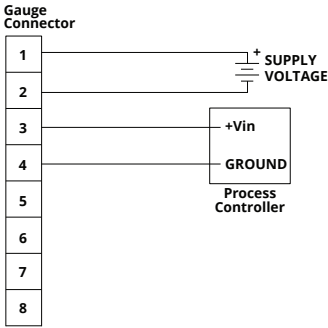

L3: 0-5 V (C4 relay option shown)

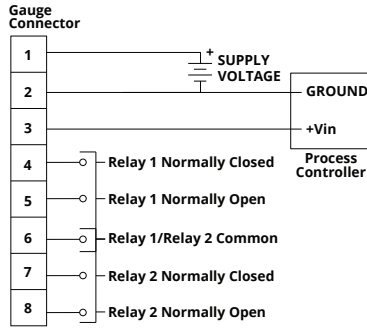

L4: External Power (C4 relay option shown)

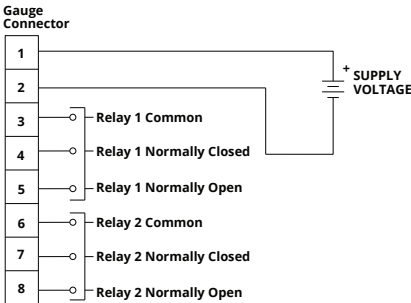

L5: RS-485 (C4 relay option shown)

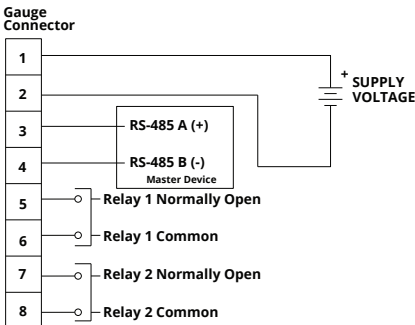

Specifications:

Overpressure: 2x full scale

Burst Pressure: 4x full scale or 20,000 psig, whichever is less.

Accuracy (linearity & hysteresis): +/-0.25% or +/- 0.1% B.F.S.L.

Environmental:

Housing: IP65

Compensated Temp: 20 to 130°F (-7 to 54°C)

Storage Temp: -40 to 160°F (-40 to 71°C)

Operating Temp: 0 to 160°F (-18 to 71°C)

Electrical:

Batteries: (2) standard C cell

External Power: 9-28 VDC

Physical:

Weight: 1.6 lb (0.73 kg)

Case Material: Injection molded Phenolic

Output Specifications:**4-20 mA Output:**

Input Voltage (Excitation): 9 VDC min (no load) to 28 VDC max

Input Current: 3-30 mA max

Signal Variance: +/-0.16 mA at set points

Output/Input: 2 wire loop powered

Resolution: 14 bit

Protection: Reversed polarity

0-2 VDC Output:

Input Voltage (excitation): Battery powered

Output: Zero set point is +/-0.15 V with a 2 VDC span +/-0.02 VDC

Output/Input: 2 wire

Resolution: 14 bit

0-5 VDC Output:

Input Voltage (Excitation): 9 to 28 VDC

Input Current: 6 mA max

Output: 0-5 VDC / +/-0.5 VDC at set points

Output/Input: Non-isolated 3 wire

Resolution: 14 bit

Protection: Reversed polarity

SPDT Relay Trip Points:

Maximum Switched Voltage: 240 VAC, 220 VDC Max

Maximum Switched Current: 5 A

Notes

Notes

AUTOMATION PRODUCTS GROUP, INC.



Automation Products Group, Inc.

Tel: 1/888/525-7300

1/435/753-7300

Fax: 1/435/753-7490

e-mail: sales@apgsensors.com

www.apgsensors.com

Automation Products Group, Inc.

1025 W. 1700 N.

Logan, UT 84321